



**Asepsis - Asepsis - Asepsia**  
**Nail Scissors, Nail Nippers**  
**Nagelscheren, Nagelzangen**  
**Tijeras para uñas, Pinzas corta - uñas**



1/2

29-100-10  
10 cm

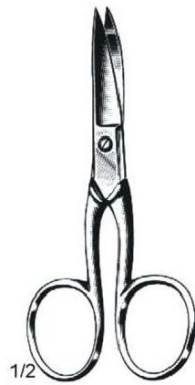

1/2

29-105-10  
10 cm



1/2

29-120-14  
14 cm



29-124-14 14 cm  
29-124-16 16 cm



Turnbull

29-128-11 11.5 cm  
29-128-13 13.0 cm



1/2

29-132-13  
13 cm



1/2

29-136-12  
12 cm



29-140-11 11 cm  
29-140-13 13 cm  
29-140-15 15 cm



**Asepsis - Asepsis - Asepsia**  
**Cuticle Nippers, Cuticle Scissors, Nail Files**  
**Nagelhautzangen, Hautscheren, Nagelfeilen**  
**Pinzas y Tijeras cuticulares, Lima para uñas**



29-144-11 11 cm  
29-144-13 13 cm



29-148-10  
10.5 cm

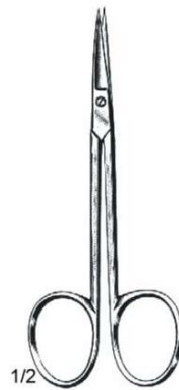

29-160-10  
10.5 cm

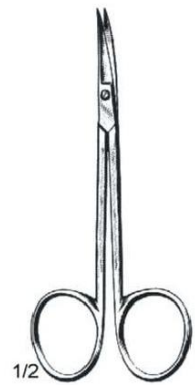

29-161-10  
10.5 cm

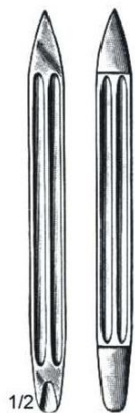

29-170-11  
11 cm



29-172-10 10 cm  
29-172-12 12 cm



29-174-11  
11 cm



29-176-16  
16 cm



**Asepsis - Asepsis - Asepsia**  
**Brush and Towel Baskets, Soap Dishes**  
**Bürsten-und Handtuchablagekörbe, Seifenschalen**  
**Cestos para cepillos y toallas, Jaboneras**



29-180-00  
200 x 200 x 100 mm

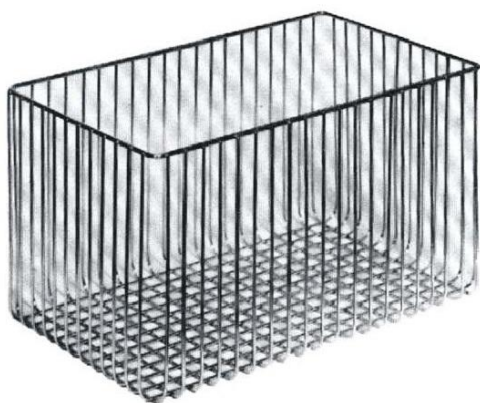

29-184-25  
250 x 150 x 150 mm



29-188-11  
110 x 75 x 13mm



**Sterilization - Sterilisation - Esterilización**  
**Sterilizing Forceps**  
**Sterilisierzangen**  
**Pinzas para esterilización**



29-190-16 16 cm  
29-190-24 24 cm



29-196-20 20 cm  
29-196-28 28 cm



29-197-20 20 cm  
29-197-28 28 cm



**Sterilization - Sterilisation - Esterilización**  
**Sterilizing Forceps**  
**Sterilisierzangen**  
**Pinzas para esterilización**



**Cheatle**  
29-211-27  
27 cm



29-215-20 20 cm  
29-215-30 30 cm



**Rogge**  
29-219-23  
23 cm



**Sterilization - Sterilisation - Esterilización**  
**Sterilizing Forceps**  
**Sterilisierzangen**  
**Pinzas para esterilización**



29-230-24  
24 cm



Ullevaal  
29-235-24  
24 cm



Harrison  
29-239-30  
30 cm



**Sterilization, Storage - Sterilisation und Aufbewahrung**  
**Dressing Sterilizing Drums**  
**Verbandstofftrommeln**  
**Cajas (Tambores) para esterilización**

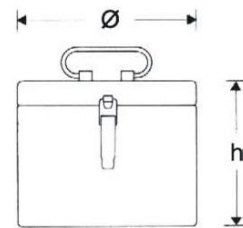

Schimmelbusch

sizes in mm (Ø x h)

29-300-01	80 x 80
29-300-02	120 x 80
29-300-03	120 x 120
29-300-04	140 x 140
29-300-05	160 x 120
29-300-06	160 x 160
29-300-07	190 x 120
29-300-08	190 x 140
29-300-09	190 x 190
29-300-10	240 x 120
29-300-11	240 x 160
29-300-12	240 x 180
29-300-13	240 x 240
29-300-14	290 x 120
29-300-15	290 x 160
29-300-16	290 x 240
29-300-17	290 x 290
29-300-18	340 x 120
29-300-19	340 x 160
29-300-20	340 x 240
29-300-21	340 x 340
29-300-22	390 x 190
29-300-23	390 x 290



**Sterilization, Storage - Esterilización, Conservación**  
**Sterilizing Boxes**  
**Sterilisierbehälter**  
**Cajas para la esterilización**

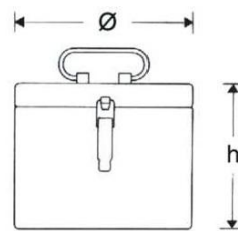

Konrich

sizes in mm (Ø x h)

29-304-01	80 x 80
29-304-02	120 x 80
29-304-03	120 x 120
29-304-04	140 x 140
29-304-05	160 x 120
29-304-06	160 x 160
29-304-07	190 x 120
29-304-08	190 x 140
29-304-09	190 x 190
29-304-10	240 x 120
29-304-11	240 x 160
29-304-12	240 x 180
29-304-13	240 x 240
29-304-14	290 x 120
29-304-15	290 x 160
29-304-16	290 x 240
29-304-17	290 x 290
29-304-18	340 x 120
29-304-19	340 x 160
29-304-20	340 x 240
29-304-21	340 x 340
29-304-22	390 x 190
29-304-23	390 x 290





**Sterilization, Storage - Sterilisation und Aufbewahrung**  
**Sterilizing Cases**  
**Sterilisierbehälter**  
**Cajas de esterilización**



29-310-75  
120 x 65 x 13 mm

Box (without Bulldog clamps, without Silicone tape)



29-314-75  
120 x 65 x 13 mm

Box with support (without Bulldog clamps)



29-318-75  
120 x 65 x 13 mm

Box with support (without instruments)



29-322-12  
120 x 120 mm

Storing cup for micro instruments



**Sterilization, Storage - Esterilización, Conservación**  
**Needle Sterilizing Cases**  
**Nadel - Sterilisierkästen**  
**Estuches para esterilizar agujas**

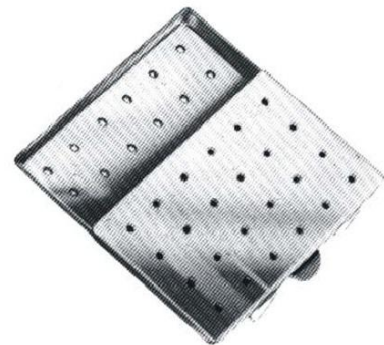
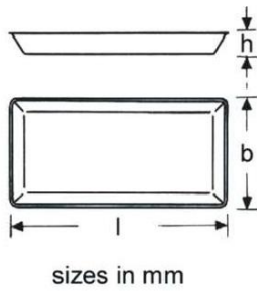

29-330-50  
 29-330-65  
 29-330-75

50 x 25 x 4.5 mm  
 65 x 42 x 8.0 mm  
 75 x 25 x 4.5 mm

29-332-50  
 29-332-65  
 29-332-75

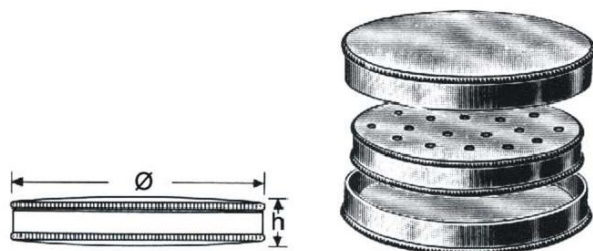

29-338-65  
 Ø = 65 mm  
 h = 15 mm

complete

29-339-65  
 Ø = 62 mm  
 h = 13 mm

insert only



**Sterilization, Storage - Sterilisation und Aufbewahrung**  
**Needle Sterilizing Cases**  
**Nadel - Sterilisierkästen**  
**Estuches para esterilizar agujas**



29-346-30 200 x 100 x 30 mm  
29-346-40 200 x 100 x 40 mm  
29-346-50 200 x 100 x 50 mm



Sauerbruch  
29-354-20  
200 x 100 x 17 mm



Sauerbruch  
29-356-20  
200 x 100 x 17 mm



**Sterilization, Storage - Esterilización, Conservación**  
**Needle Sterilizing Cases**  
**Nadel - Sterilisierkästen**  
**Estuches para esterilizar agujas**



29-360-01  
150 x 95 x 13 mm



29-360-02  
150 x 95 x 13 mm



29-360-03  
150 x 95 x 13 mm



29-360-04  
150 x 95 x 13 mm



29-362-01  
150 x 95 x 13 mm



29-362-02  
150 x 95 x 13 mm

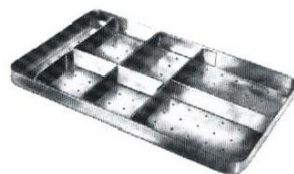

29-364-01  
150 x 95 x 11 mm



**Sterilization, Storage - Sterilisation und Aufbewahrung**  
**Sterilizing Forceps**  
**Kappenzangen**  
**Combinación tapa / pinzas**



29-370-25 25 cm  
29-370-32 32 cm

**Sterilization, Storage - Esterilización, Conservación**  
**Sterilizing and Storing Cases**  
**Sterilisier-und Bereitschaftskästen**  
**Cajas para esterilización y conservación**

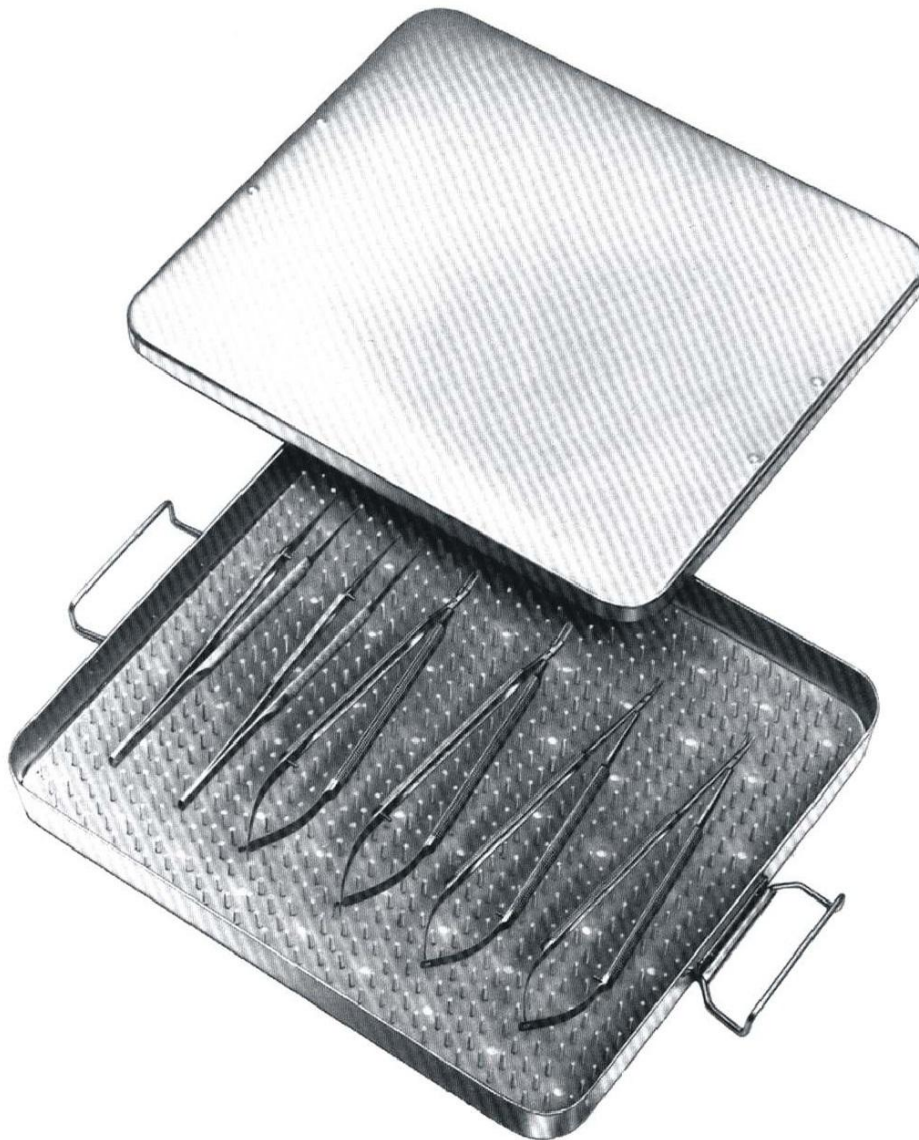

29-376-20	200 x 100 x 25 mm
29-376-23	230 x 150 x 25 mm
29-376-25	250 x 200 x 25 mm
29-376-28	280 x 280 x 25 mm

Micro instrument tray without silicone mat



**Sterilization, Storage - Sterilisation und Aufbewahrung**  
**Sterilizing and Storing Cases**  
**Sterilisier-und Bereitschaftskästen**  
**Cajas para esterilización y conservación**



sizes in mm (l x b x h)	Containers
230 x 120 x 50	29-380-23
250 x 125 x 50	29-380-25
300 x 150 x 50	29-380-30
350 x 175 x 50	29-380-35
400 x 200 x 50	29-380-40
300 x 150 x 75	29-382-30
350 x 175 x 75	29-382-35
400 x 200 x 75	29-382-40



**Sterilization, Storage - Esterilización, Conservación**  
**Sterile Deposit System**  
**Steri - Depot - System**  
**Sistema de depósito estéril**



29-390-50	300 x 150 x 50 mm
29-390-65	300 x 150 x 65 mm
29-390-80	300 x 150 x 80 mm

All bottoms with filters





**Sterilization, Storage - Sterilisation und Aufbewahrung**  
**Sterilie Deposit System**  
**Steri - Depot - System**  
**Sistema de depósito estéril**

Table - top model



29-392-00

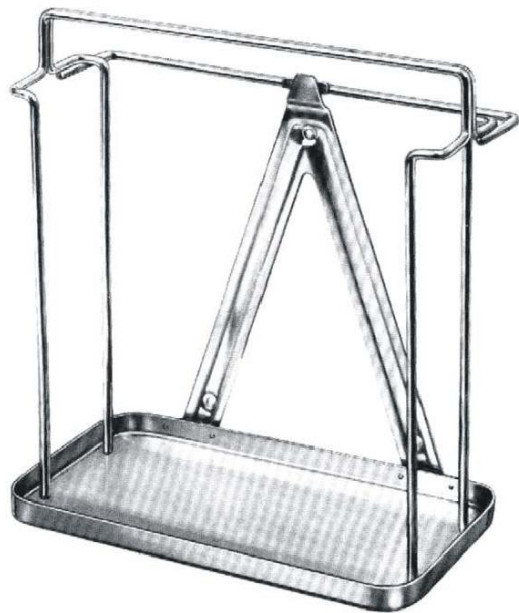

29-392-01



**Sterilization, Storage - Esterilización, Conservación**  
**Safety pins**  
**Sterilisierklemmern**  
**Cadres de estérilización**



Mayo  
29-410-14  
14 cm



Mayo  
29-414-14  
14 cm



Bunt  
29-418-12  
12 cm



**Sterilization, Storage - Sterilisation und Aufbewahrung**  
**Sterilizing Racks**  
**Sterilisierrahmen**  
**Porta - instrumentos**

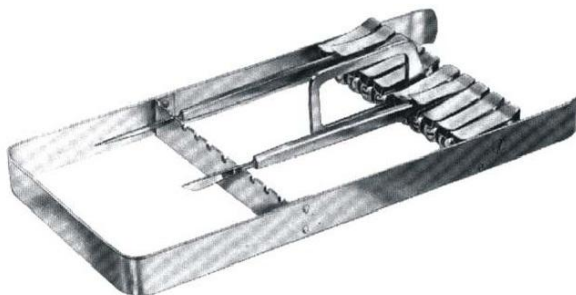

29-424-10  
190 x 96x 30 mm

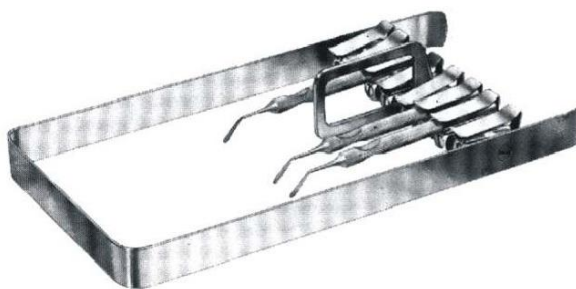

29-426-08  
190 x 96x 30 mm

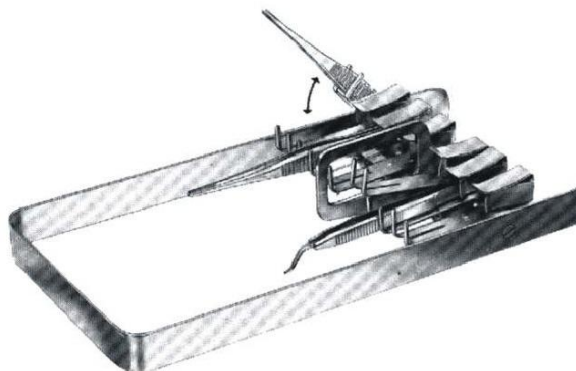

29-428-06  
190 x 96x 30 mm

**Sterilization, Storage - Esterilización, Conservación**  
**Sterilizing Trays**  
**Sterilisiersiebschalen**  
**Bandejas de esterilización**



sizes in mm (l x b x h)

29-440-01	240 x 250 x 30
29-440-02	240 x 250 x 50
29-440-03	240 x 250 x 70
29-440-04	240 x 250 x 100
29-440-05	400 x 250 x 30
29-440-06	400 x 250 x 50
29-440-07	400 x 250 x 70
29-440-08	400 x 250 x 100
29-440-09	480 x 250 x 30
29-440-10	480 x 250 x 50
29-440-11	480 x 250 x 70
29-440-12	480 x 250 x 100
29-440-13	510 x 250 x 50
29-440-14	510 x 250 x 70
29-440-15	510 x 250 x 100
29-440-16	550 x 250 x 50
29-440-17	550 x 250 x 70
29-440-18	550 x 250 x 100



sizes in mm (l x b x h)

29-446-01	240 x 240 x 50
29-446-02	240 x 240 x 80
29-446-03	240 x 240 x 100
29-446-04	260 x 260 x 100
29-446-05	480 x 260 x 50
29-446-06	500 x 260 x 50
29-446-07	510 x 200 x 40
29-446-08	520 x 260 x 80
29-446-09	520 x 260 x 100



**Sterilization, Storage - Sterilisation und Aufbewahrung**  
**Sterilizing Baskets**  
**Sterilisier - Körbe**  
**Ceste de esterilización**



29-454-15  
60 x 30 x 15 cm



29-454-30  
60 x 30 x 30 cm



**Containers - Behälter, Stationsgefäße - Recipientes  
Solution Bowls, Wash Bowls  
Spülschalen (Kummen), Waschschüssel  
Cubetas para soluciones, Palanganas**

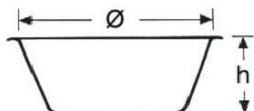

sizes in mm (Ø x h)

29-500-04	40 x 20
29-500-06	60 x 30
29-500-08	80 x 40
29-500-10	100 x 50
29-500-12	120 x 55
29-500-15	150 x 75
29-500-18	180 x 85
29-500-20	200 x 90
29-500-22	225 x 100
29-500-24	240 x 110
29-500-27	275 x 115
29-500-29	290 x 125
29-500-31	310 x 125
29-500-34	345 x 125
29-500-38	380 x 130

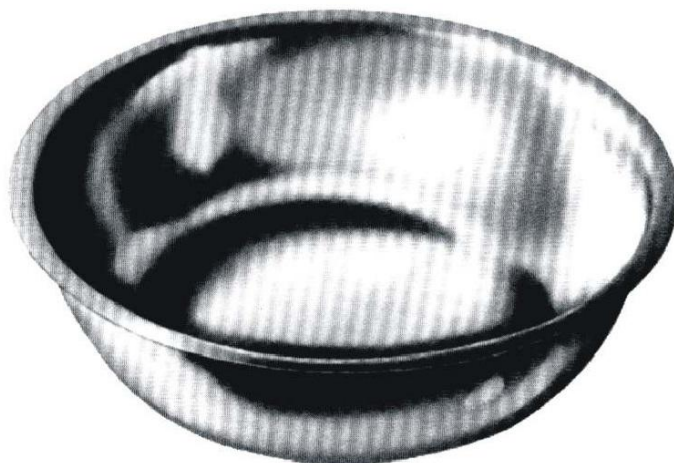

Ø mm

29-506-30	300 x 100
29-506-35	350 x 120



**Containers - Behälter, Stationsgefäße - Recipientes**  
**Round Bowls, Graduated Measures**  
**Runde Schalen, Meßbecher**  
**Cubetas redonadas, Copas graduadas**

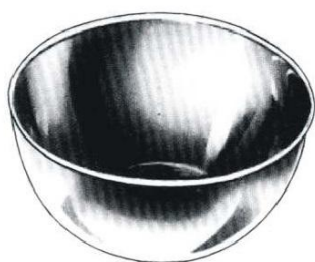

sizes in mm (Ø x h)

29-510-04	40 x 20
29-510-06	60 x 30
29-510-08	80 x 40
29-510-10	100 x 50
29-510-12	120 x 55
29-510-14	140 x 65
29-510-15	150 x 75
29-510-18	180 x 85

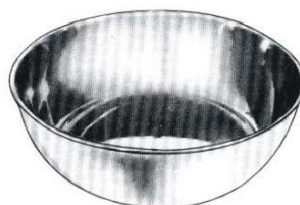

sizes in mm (Ø x h)

29-514-10	100 x 35
29-514-12	120 x 40
29-514-14	140 x 40
29-514-15	150 x 45
29-514-18	180 x 45

sizes in mm (Ø x h)



29-518-28  
110 x 28



29-524-01  
100 cc



29-526-02 0.25 l  
 29-526-05 0.50 l  
 29-526-10 1.00 l  
 29-526-20 2.00 l

**Containers - Behälter, Stationsgefäße - Recipientes  
Universal Trays, Instruments Storing Trays  
Eckige Mehrzweckschalen, Instrumentenablegeplatten  
Bandejas para instrumentos etc.**

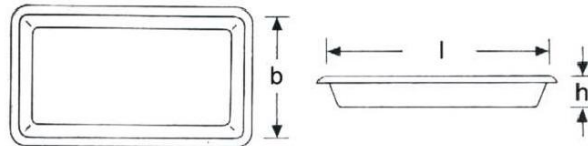

Available in different heights

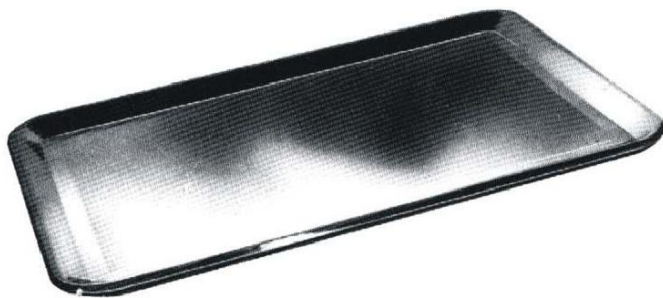

sizes in mm (l x b x h)

29-532-01	180 x 130 x 10
29-532-02	200 x 150 x 10
29-532-03	220 x 170 x 10
29-532-04	240 x 140 x 10
29-532-05	250 x 200 x 10
29-532-06	300 x 150 x 10
29-532-07	300 x 200 x 10
29-532-08	300 x 250 x 10
29-532-09	350 x 300 x 10
29-532-10	370 x 270 x 10
29-532-11	400 x 300 x 10
29-532-12	400 x 350 x 10
29-532-13	450 x 300 x 10
29-532-14	460 x 300 x 10
29-532-15	460 x 360 x 10
29-532-16	490 x 300 x 10
29-532-17	500 x 200 x 10



sizes in mm (l x b x h)

29-536-01	180 x 130 x 50
29-536-02	200 x 150 x 50
29-536-03	220 x 170 x 50
29-536-04	240 x 140 x 50
29-536-05	250 x 200 x 50
29-536-06	300 x 150 x 50
29-536-07	300 x 200 x 50
29-536-08	300 x 250 x 50
29-536-09	350 x 300 x 50
29-536-10	370 x 270 x 50
29-536-11	400 x 300 x 50
29-536-12	400 x 350 x 50
29-536-13	450 x 300 x 50
29-536-14	460 x 300 x 50
29-536-15	460 x 360 x 50
29-536-16	490 x 300 x 50
29-536-17	500 x 200 x 50





**Containers - Behälter, Stationsgefäße - Recipientes  
Trays and Jars  
Schwenkschalen, Standgefäße  
Bandejas rectangulares y redondas, Tarros**

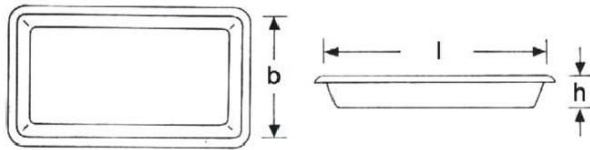

Available in different heights



sizes in mm (l x b x h)

29-540-01	180 x 130 x 30
29-540-02	200 x 150 x 30
29-540-03	220 x 170 x 30
29-540-04	240 x 140 x 30
29-540-05	250 x 200 x 30
29-540-06	300 x 150 x 30
29-540-07	300 x 200 x 30
29-540-08	300 x 250 x 30
29-540-09	350 x 300 x 30
29-540-10	370 x 270 x 30
29-540-11	400 x 300 x 30
29-540-12	400 x 350 x 30
29-540-13	450 x 300 x 30
29-540-14	460 x 300 x 30
29-540-15	460 x 360 x 30
29-540-16	490 x 300 x 30
29-540-17	500 x 200 x 30

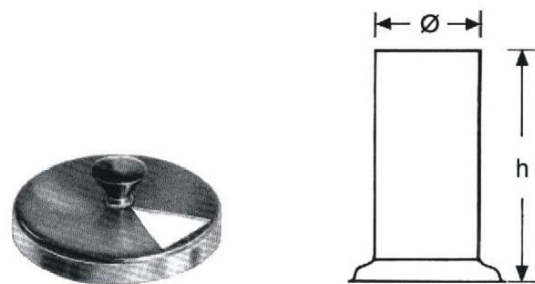

jar without lid

lid only

lid only with triangle hole

sizes in mm (Ø x h)

29-550-01	29-554-01	29-556-01	30 x 90
29-550-02	29-554-02	29-556-02	52 x 100
29-550-03	29-554-03	29-556-03	52 x 130
29-550-04	29-554-04	29-556-04	52 x 180
29-550-05	29-554-05	29-556-05	70 x 100
29-550-06	29-554-06	29-556-06	70 x 130
29-550-07	29-554-07	29-556-07	70 x 180
29-550-08	29-554-08	29-556-08	70 x 200
29-550-09	29-554-09	29-556-09	100 x 180
29-550-10	29-554-10	29-556-10	100 x 200
29-550-11	29-554-11	29-556-11	125 x 175

**Containers - Behälter, Stationsgefäße - Recipientes**  
**Instrument Boxes**  
**Instrumentenkästen**  
**Cajas para instrumentos**

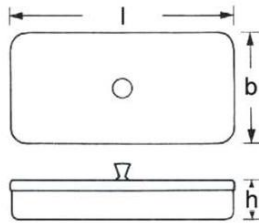

lid with knob	lid without knob	sizes in mm (l x b x h)
29-560-01	29-562-01	150 x 65 x 25
29-560-02	29-562-02	170 x 70 x 30
29-560-03	29-562-03	180 x 80 x 40
29-560-04	29-562-04	180 x 120 x 60
29-560-05	29-562-05	200 x 100 x 40
29-560-06	29-562-06	200 x 100 x 60
29-560-07	29-562-07	220 x 120 x 60
29-560-08	29-562-08	250 x 125 x 45
29-560-09	29-562-09	300 x 120 x 60
29-560-10	29-562-10	300 x 150 x 50
29-560-11	29-562-11	320 x 165 x 55
29-560-12	29-562-12	340 x 165 x 75
29-560-13	29-562-13	400 x 160 x 75
29-560-14	29-562-14	500 x 200 x 75



sizes in mm (l x b x h)	
29-566-01	150 x 65 x 25
29-566-02	170 x 70 x 30
29-566-03	180 x 80 x 40
29-566-04	180 x 120 x 60
29-566-05	200 x 100 x 40
29-566-06	200 x 100 x 60
29-566-07	220 x 120 x 60
29-566-08	250 x 125 x 45
29-566-09	300 x 120 x 60
29-566-10	300 x 150 x 50
29-566-11	320 x 165 x 55
29-566-12	340 x 165 x 75
29-566-13	400 x 160 x 75
29-566-14	500 x 200 x 75



**Containers - Behälter, Stationsgefäße - Recipientes**  
**Containers for cotton wool, pellets**  
**Dosen für Watte, Tampons**  
**Recipientes para algodón, tapones**

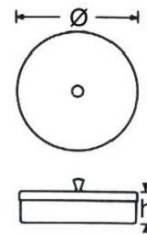

lid with knob	lid without knob	sizes in mm (Ø x h)
29-574-01	29-576-01	80 x 60
29-574-02	29-576-02	80 x 80
29-574-03	29-576-03	100 x 60
29-574-04	29-576-04	120 x 80
29-574-05	29-576-05	100 x 100
29-574-06	29-576-06	120 x 120
29-574-07	29-576-07	150 x 150
29-574-08	29-576-08	180 x 180
29-574-09	29-576-09	200 x 200
29-574-10	29-576-10	250 x 250



**Containers - Behälter, Stationsgefäße - Recipientes**  
**Medicine Cups and Spoons, Petri Dishes**  
**Medizinbecher, läffel, Petrischalen**  
**Vasos y Cucharas graduados, Cápsulas de Petri**



29-580-01 025 cc  
29-580-02 050 cc  
29-580-03 075 cc  
29-580-04 100 cc



29-586-15  
15 cc

sizes in mm (Ø x h)



with lid

29-590-10 100 x 20



without lid

29-592-09 96 x 20



29-593-10



**Containers - Behälter, Stationsgefäße - Recipientes**  
**Irrigators**  
**Irrigatoren**  
**Irrigadores**



29-600-10	1.0 l
29-600-15	1.5 l
29-600-20	2.0 l



**Patient's Articles - Patientenartikel**  
**Containers for Duntures, Sputum Cups**  
**Zahnprothesenschale, Sputumbecher**  
**Tarros para prótesis dental, Escupideras**



29-650-25  
Ø 180 x 125 mm



29-652-60  
Ø 100 x 60 mm



29-654-95  
Ø 120 x 95 mm

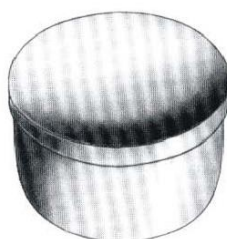

29-656-50  
Ø 100 x 50 mm



29-658-50  
Ø 100 x 50 mm



**Patient's Articles - Artículos para pacientes**  
**Kidney Bowls, Bed Pans**  
**Nierenschalen, Stechbecken**  
**Cuñas**

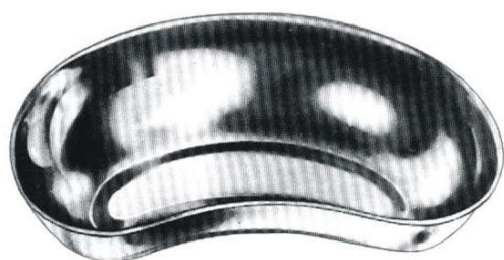

bowl only

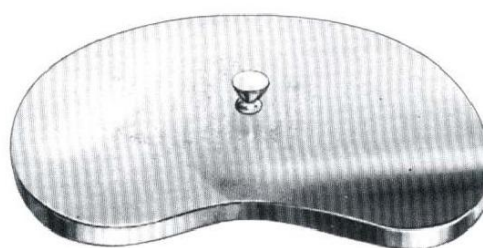

lid only

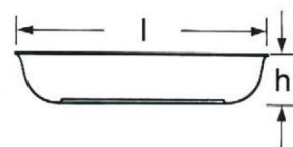

sizes in mm (l x h)

29-670-15  
 29-670-20  
 29-670-23  
 29-670-25  
 29-670-28  
 29-670-30

29-672-15  
 29-672-20  
 29-672-23  
 29-672-25  
 29-672-28  
 29-672-30

150 x 65  
 200 x 90  
 235 x 105  
 250 x 115  
 280 x 120  
 300 x 140



lid with knob

Ø mm

29-676-29

290

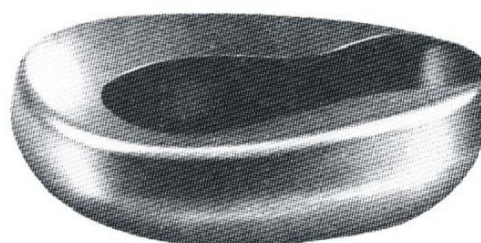

sizes in mm (l x b)

29-680-31  
 29-680-35

310 x 240  
 350 x 290



**Miscellaneous - Verschiedenes - Diversos artículos**  
**Triangular Basin, Placenta Pan**  
**Dreieckschalen, Placentabecken**  
**Cubetas triangulares para urología, Cubetas para placenta**

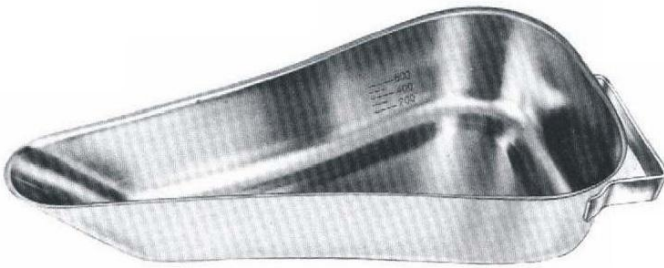

29-686-30

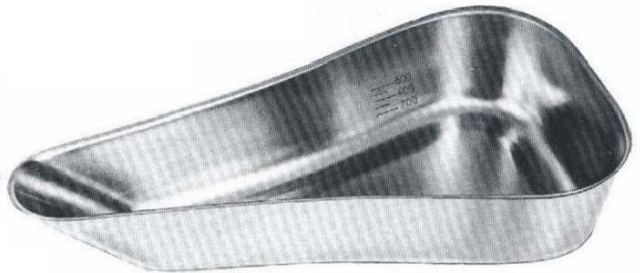

29-688-30



29-694-36





**Miscellaneous - Verschiedenes - Diversos artículos**  
**Guaze and Cotton Dispenser, Powder Strewer**  
**Gazepender, Punderstreudose**  
**Distribuidores para gasa, algodón**

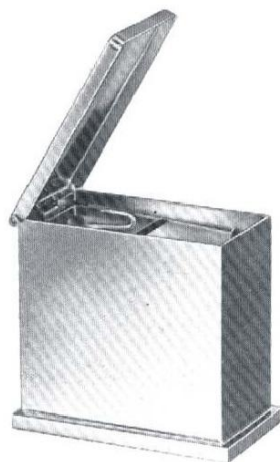

Luniatschek  
29-700-60  
60 x 60 x 30 mm



29-706-10  
Ø 50 x 100 mm



Miscellaneous - Verschiedenes - Diversos artículos  
Cotton Receptacles  
Wattespender, Watteabfallbehälter  
Recipientes para desperdicios



Methot  
29-714-01  
Ø 50 x 75 mm



Methot  
29-714-02  
Ø 50 x 75 mm



Methot  
29-716-01  
Ø 50 x 75 mm



Miscellaneous - Verschiedenes - Diversos artículos  
Alcohol Burners  
Spirituslampen  
Lámparas de alcohol



29-730-10 100 cc  
29-730-12 120 cc  
29-730-15 150 cc  
29-730-20 200 cc



29-734-10 100 cc  
29-734-12 120 cc  
29-734-15 150 cc  
29-734-20 200 cc



29-738-10 100 cc  
29-738-12 120 cc  
29-738-15 150 cc  
29-738-20 200 cc



Miscellaneous - Verschiedenes - Diversos artículos  
Tubing Clamps  
Schlauchklemmen  
Cierra - tubos (Llaves de compresión)



29-754-12	12 - 17
29-754-16	16 - 21
29-754-20	20 - 25
29-754-24	24 - 29

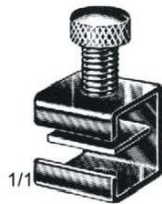

Simplex  
29-758-12  
12 mm



Hoffmann	
29-762-13	13 mm
29-762-17	17 mm
29-762-20	20 mm
29-762-25	25 mm
29-762-30	30 mm
29-762-40	40 mm
29-762-50	50 mm

**Hospital Equipments - Mobiliar - Muebles**  
**Mobile carriers for infusion and oxygen cylinders**  
**Fahrbare Ständer für Infusion und Gasflaschen**  
**Soportes móviles para infusión y botellas de gas**

Oxygen Cylinder Carriage



29-800-01 (Powder Coated)  
29-800-02 (Stainless Steel)

29-804-01 (Powder Coated)  
29-804-02 (Stainless Steel)

Infusion stand with 4 hooks



29-816-01  
(Powder Coated)

29-816-02  
(Stainless Steel)



**Hospital Equipments - Mobiliar - Muebles**  
**Mobile carriers for Buckets and Basins**  
**Fahebare Ständer für Eimern und Schüsseln**  
**Soportes móviles para cubos y palanganas**

with guide bar



29-822-01 (Powder Coated)  
29-822-02 (Stainless Steel)

without guide bar  
(Kick Bucket)



29-826-01 (Powder Coated)  
29-826-02 (Stainless Steel)



29-830-01 (Powder Coated)  
29-830-02 (Stainless Steel)

Wash Basin Stands



29-834-01 (Powder Coated)  
29-834-02 (Stainless Steel)



**Hospital Equipments - Mobiliar - Muebles**  
**Arm and Leg Rest, Steps**  
**Arm-und Beinstütze, Auftritte**  
**Apoyos de brazo y pierna, Banquetas**

Arm and Leg Rest



29-836-00

Steps



29-842-01 (Powder Coated)  
29-842-02 (Stainless Steel)



29-846-01 (Powder Coated)  
29-846-02 (Stainless Steel)

**Hospital Equipments - Mobiliar - Muebles**  
**Sphygmomanometer, Examonation Lamp**  
**Blutdruckmeßapparate, Licht für recongnition**  
**Esfimomanómetro, Luz para reconocimiento**



Plastic base  
 Range 0-300 mm/Hg  
 Base with 5 castors  
 Locking btake

29-860-01



Stainless steel base  
 Range 0-300 mm/Hg  
 Base with 5 castors  
 Locking btake

29-860-02

Examination lamp



29-880-01

Examination lamp with halogen bulb



29-880-02



29-880-03

Chrome plated steel tubing  
 Stainless steel base with 5 castors





**Cleaning - Reinigung - Limpieza  
 Waste Buckets, Waste Forceps  
 Abwurf und Abfalleimer, Abfallzangen  
 Cubos y Pinzas para desechos**

Waste Bucket



- 29-900-08 8 l
- 29-900-10 10 l
- 29-900-12 12 l
- 29-900-15 15 l
- 29-900-20 20 l

Lid



- 29-901-08
- 29-901-10
- 29-901-12
- 29-901-15
- 29-901-20



29-920-58  
58 cm



Sauerbruch  
29-924-58  
58 cm



**Hospital Equipments - Mobiliar - Muebles**  
**Examination Couch**  
**Untersuchungsliegen**  
**Cama de reconocimiento**

Dimensions: 180 x 55 x 80 (H) cm  
Constructed from chrome-plated square steel tube  
Fully adjustable head rest  
Upholstered top  
Washable & flame retardant material  
Knock down construction

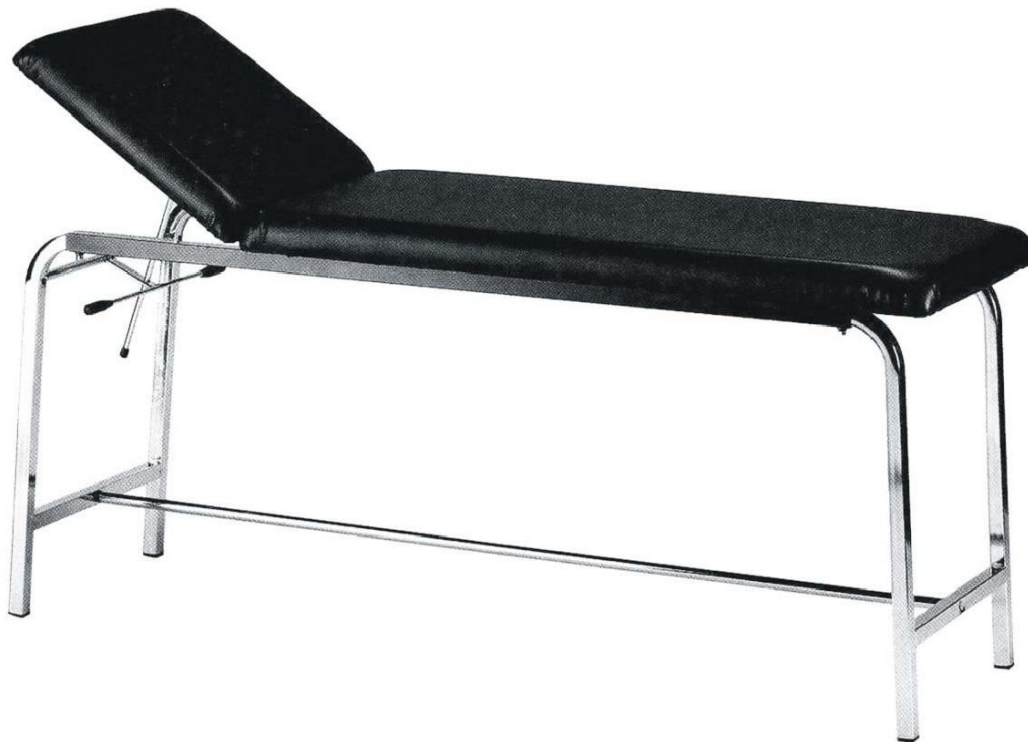

Examination Couch  
29-930-01



**Hospital Equipments - Mobiliar - Muebles**  
**Examination Couch**  
**Untersuchungsliegen**  
**Cama de reconocimiento**

Dimensions: 180 x 55 x 80 (H) cm  
Constructed from chrome-plated round steel tube  
Fully adjustable head rest  
Upholstered top  
Washable & flame retardant material  
Knock down construction



Examination Couch  
29-930-02



**Hospital Equipments - Mobiliar - Muebles**  
**Examination Couch**  
**Untersuchungsliegen**  
**Cama de reconocimiento**

Dimensions: 180 x 55 x 80 (H) cm  
Constructed from chrome-plated round steel tube  
Adjustable back rest & leg sections  
Upholstered top  
Washable & flame retardant material  
Knock down construction



Examination Couch  
29-930-03



**Hospital Equipments - Mobiliar - Muebles**  
**Examination Couch**  
**Untersuchungsliegen**  
**Cama de reconocimiento**

Dimensions: 180 x 55 x 80 (H) cm  
Constructed from chrome-plated rectangular steel tube  
Adjustable back rest & leg sections  
Upholstered top  
Washable & flame retardant material  
Complete with stainless steel bowl Ø 32 cm  
Knock down construction



Gynecological Couch  
29-940-01



**Hospital Equipments - Mobiliar - Muebles**  
**Delivery Bed**  
**Anlieferungsbett**  
**Cama para partos**

Dimensions: 180 x 55 x 80 (H) cm  
Constructed from chrome-plated steel tube  
Three sections with independent controls  
Leg section movable on casters, two casters with brakes  
Complete with padded shoulder rest, leg-holders & stainless steel bowl Ø 32 cm  
Upholstered top  
Washable & flame retardant material  
Knock down construction



Delivery Bed  
29-946-01



**Hospital Equipments - Mobiliar - Muebles**  
**Instrument Trolley**  
**Instrumente - Laufkatze**  
**Carro para instrumental**

70 x 50 x 80 (H) cm



Instrument Trolley  
29-950-01

29-950-02 60 x 40 x 80 (H) cm  
 29-950-03 70 x 50 x 80 (H) cm  
 29-950-04 90 x 60 x 80 (H) cm



Instrument Trolley  
29-950-02 - 29-950-04

Stainless steel bowl Ø 32 mm

29-950-05 70 x 50 x 80 (H) cm 1 Drawer  
 29-950-06 70 x 50 x 80 (H) cm 2 Drawer



Trolley  
29-950-05 - 29-950-06

Stainless steel bottle rack  
 Stainless steel bowl Ø 32 mm  
 Rectangular waste bin

90 x 60 x 80 (H) cm



Dressing Trolley  
29-950-07



**Hospital Equipments - Mobiliar - Muebles**  
**Mayo Table**  
**Mayo - Tabelle**  
**Mesa de mayo**

Variable height: 90 to 125 cm  
Stainless Steel Construction  
Four caster base Ø 50 mm  
Removable stainless steel tray 70 x 45 x 3 (H) cm



Mayo Table  
29-960-01

Variable height: 80 to 115 cm  
Stainless Steel Construction  
Four caster base Ø 50 mm  
Removable stainless steel tray 70 x 45 x 3 (H) cm



Mayo Table  
29-960-02





**Hospital Equipments - Mobiliar - Muebles**  
**Stainless Steel Carts, Ward Trolley**  
**Edelstahl - Karren, Bezirk - Laufkatze**  
**Carros de acero inoxidable, Carro**

Glazed stainless steel AISI 304  
 Removable shelves with raised edges to avoid spilling

29-970-01 65 x 45 x 80 (H) cm  
 29-970-02 80 x 50 x 90 (H) cm  
 29-970-03 85 x 55 x 93 (H) cm  
 29-970-04 107 x 63 x 93 (H) cm

29-974-01 80 x 50 x 80 (H) cm  
 29-974-02 80 x 50 x 90 (H) cm  
 29-974-03 85 x 55 x 90 (H) cm  
 29-974-04 107 x 63 x 93 (H) cm



Cart  
 29-970-01 - 29-970-04



Cart  
 29-974-01 - 29-974-04

Epoxy coated steel  
 Shelves with upstands on four sides  
 Push handle  
 Mounted on Ø 80mm casters



Ward Trolley  
 29-978-01 - 29-978-02

29-978-01 70 x 43 x 85 (H) cm 2 Drawer  
 29-978-02 70 x 43 x 85 (H) cm 3 Drawer



**Hospital Equipments - Mobiliar - Muebles**  
**Instrument Trolley**  
**Instrumente - Laufkatze**  
**Carro para instrumental**

Epoxy coated steel  
Removable shelves with upstands on three sides  
Mounted on casters  
Knock down construction

29-980-03 46 x 37 x 112 (H) cm  
Complete with electrical plug

29-980-01 46 x 37 x 77 (H) cm



29-980-02 46 x 37 x 85 (H) cm



Instrument Trolley  
29-980-01 - 29-980-03



**Hospital Equipments - Mobiliar - Muebles**  
**Ward Screen**  
**Wandschirme**  
**Biombo**

Chrome-plated steel tubular frame  
Plastic curtains washable & flame retardant  
Mounted on casters  
Knock down construction



Ward Screen  
29-986-00